

- (BG)** Инструкция за монтаж и експлоатация
- (ENG)** Instruction for installation and use
- (RO)** Instrucțiune de instalare și utilizare
- (SRB)** Uputstvo za ugradnju i upotrebu
- (HR)** Uputstvo za ugradnju i upotrebu
- (BIH)** Uputstvo za ugradnju i upotrebu
- (HU)** Szerelési és kezelési utasítás
- (SLO)** Navodilo za vgradnjo in uporabo
- (GR)** Οδηγίες για την εγκατάσταση και τη χρήση
- (MK)** Упатство за вградување и употреба
- (SK)** Návod na montáž a používanie
- (PL)** Instrukcja instalacji i użytkowania
- (P)** Instrução para instalação e uso
- (IT)** Istruzioni per l'installazione e l'uso



- (BG)** Осветително тяло 955DOTS1S,2S,3S,1T/955STRIPS1S,2S,3S,1T
- (ENG)** Luminaries 955DOTS1S,2S,3S,1T/955STRIPS1S,2S,3S,1T
- (RO)** Lampa exterior 955DOTS1S,2S,3S,1T/955STRIPS1S,2S,3S,1T
- (SRB)** Svetiljka 955DOTS1S,2S,3S,1T/955STRIPS1S,2S,3S,1T
- (HR)** Rasvjetna tijela 955DOTS1S,2S,3S,1T/955STRIPS1S,2S,3S,1T
- (BIH)** Svjetiljka 955DOTS1S,2S,3S,1T/955STRIPS1S,2S,3S,1T
- (HU)** 955DOTS1S,2S,3S,1T/955STRIPS1S,2S,3S,1T Lámpatest
- (SLO)** Svetilike 955DOTS1S,2S,3S,1T/955STRIPS1S,2S,3S,1T
- (GR)** Φωτιστικά στεγανά εξ.χώρου 955DOTS1S,2S,3S,1T/955STRIPS1S,2S,3S,1T
- (MK)** Светилки 955DOTS1S,2S,3S,1T/955STRIPS1S,2S,3S,1T
- (SK)** Svietidlá 955DOTS1S,2S,3S,1T/955STRIPS1S,2S,3S,1T
- (PL)** Oprawy świetlne 955DOTS1S,2S,3S,1T/955STRIPS1S,2S,3S,1T
- (P)** Luminárias 955DOTS1S,2S,3S,1T/955STRIPS1S,2S,3S,1T
- (IT)** Luminari 955DOTS1S,2S,3S,1T/955STRIPS1S,2S,3S,1T



### DOTS / STRIPS

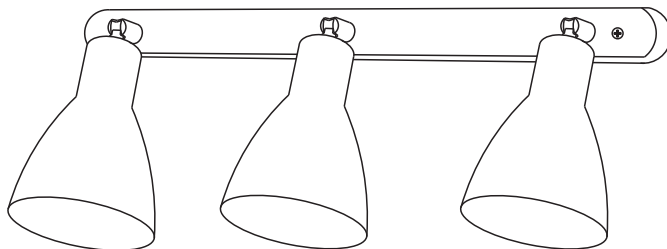

**DOTS/STRIPS**  
955DOTS3S-955STRIPS3S

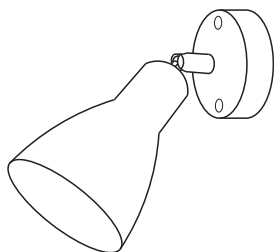

**DOTS/STRIPS**  
955DOTS1S-955STRIPS1S

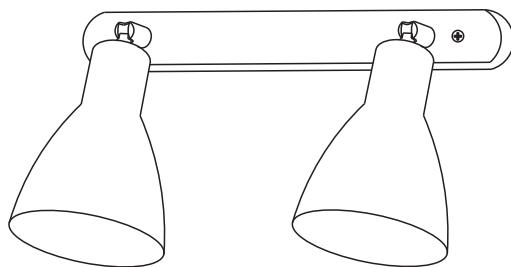

**DOTS/STRIPS**  
955DOTS2S-955STRIPS2S

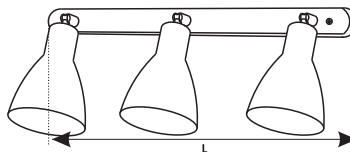
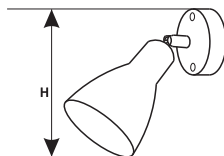
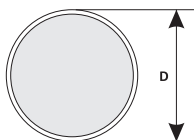

Model	Lampholder	V <sub>AC</sub>	Hz	Size (mm)		
				W / D	L	H
955DOTS1S/955STRIPS1S	E27	~230V	50/60Hz	110	205	180
955DOTS2S/955STRIPS2S	E27	~230V	50/60Hz	185	400	180
955DOTS3S/955STRIPS3S	E27	~230V	50/60Hz	185	580	180
955DOTS1T/955STRIPS1T	E27	~230V	50/60Hz	145	210	335

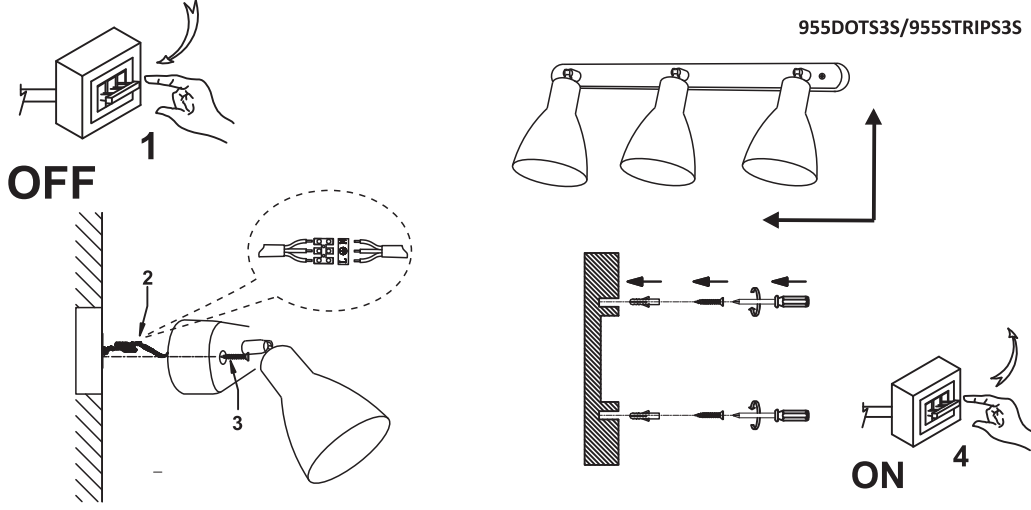
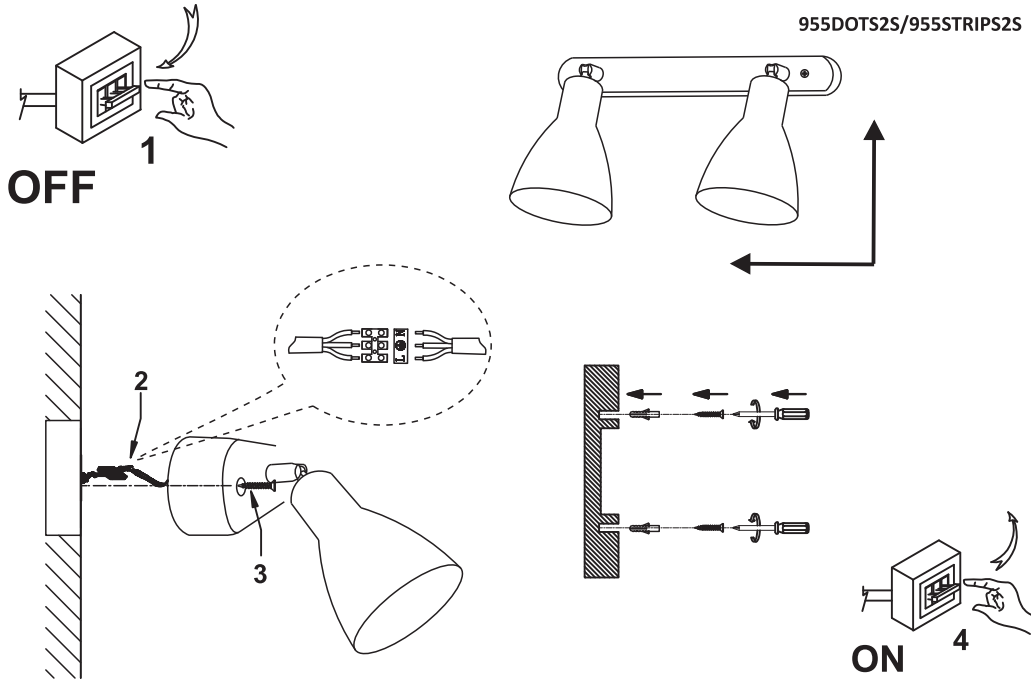
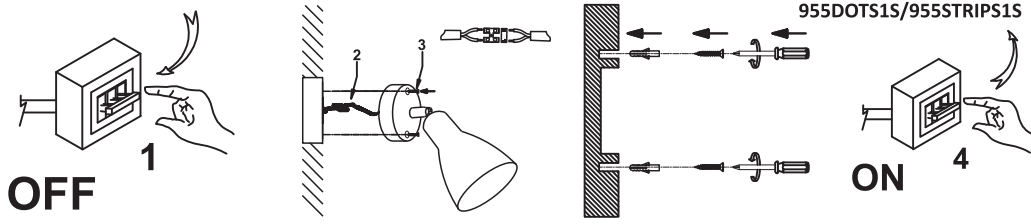

**BG** - Осветителното тяло трябва да бъде монтирано и въведено в експлоатация единствено от специалист с подходящо електротехническо образование. Преди свързването му към захранващата клема първо се уверете, че няма наранена или липсваща изолация по захранващите проводници. Цветният код на кабелите е черен или кафяв (L) - фазов проводник, син N нулев проводник и жълто-зелен - защитен (зануляващ) проводник - при тела защитени срещу поражение от електрически ток клас 1. Видът на източника на напрежение, както и останалите технически характеристики са посочени в таблица. **EN** - The light fitting must only be mounted and put into operation by a qualified electrician! Make sure that you do not damage any electric cables when you are mounting the light fitting. The colour codes of the wire are the following: black or brown (L) = phase conductor, blue (N) = neutral conductor, and in the case of a light fitting of shock protection class 1: green-yellow =protecting conductor. Only a light source of maximum performance and of the type indicated in the data plate and around the socket can be used for the product. The light fitting must only be mounted and put into operation by a qualified electrician! **D** - Die Montage und Inbetriebsetzung des Leuchtkörpers darf nur von Fachleuten vorgenommen werden! Bei der Montage des Lichtkörpers soll darauf geachtet werden, dass das elektrische Kabel nicht verletzt wird. Die Leitungen sind mit den folgenden Farben versehen: schwarz oder braun (L)=Phasenleiter, blau (N) = Nulleiter, und bei Leuchtkörpern mit Berührungsschutz klasse 1. : grün - gelb = Schutzleiter.

**CZ** - Montáž a zprovoznění lampy smí provádět výhradně jenom odborná osoba. Při montáži lampy dejte pozor na to, aby jste náhodou nepoškodil elektrický kabel. Význam používaných barev u kabelů jsou následující: černá, nebo hnědá (L) = fázový vodič, modrá (N) = nulový vodič, u lampy s proti dotykovou ochranou: zele- ná-žlutá = ochranný (uzemnění) vodič. **SLO** - Namontovanje osvetlovalnega telesa a jeho uvedenie do prevádzky môže vykonávať len odborník! Pri namontovaní osvetlovalneho telesa dbajte na to, aby ste neporušili kábel elek-trického vedenia. Farebné označenia vodičov sú nasledovné: čierna, alebo hnedá farba (L) = fazový vodič, modrá (N) = nulový vodič, a v prípade osvetlovalneho telesa patriaceho do I.triedy ochrany pred nebez-pečným dotykem: zelená-žltá = ochranný vodič. **PL** - Lampa może być zamontowana i uruchomiona tylko przez specjalistę! Przy montowaniu lampy należy uważać, aby nie uszkodzić kabla elektrycznego. Oznakowanie kolorów kabli: czarny lub brązowy (L) = przewód fazowy, niebieski (N) = przewód zerowy i w przypadku lampy I. ochrony kontaktu: zielono-żółty =przewód ochronny. **HU** - A lámpatest felszerelését és üzembe helyezését csak szakember végezheti! A lámpatest felszerelésénél vigyázzon arra, hogy ne sértsen meg elektromos ká-belt. A vezetéknek színjelölése a következők: fekete vagy barna (L) = fázisvezető, kék (N) = nulla vezető, és 1. érintésvédelmi lámpatest esetén: zöld-sárga védővezető. **SK** - Montiranje in stavljanje svetilke v obrat sme izvrševati le strokovnjak! Pri montiranju svetilke pazite da ne poškodujete električnega kabla. Barvna zaznamovanja vod so naslednja: črna ali rjava (L) = fazni vod, modra (N) = neutralni vod, in v primeru svetilke z zaščito pred dotikom: zelena- rumena = zaščitni vod. **BIH** - Montažu rasvjetnog tijela i stavljanje u pogon može izvršiti samo stručna osoba! Kod montaže rasvjetnog tijela pazite da ne oštetite električni kabel. Označavanje kablova prema bojama: crna ili smeđa (L)= faza, plava (N) = nula, i kod rasvjetnog tijela sa 1. stupnjem zaštite zeleno-žuta = uzemljenje. **SRB** - Montažu lampe i stavljanje u pogon može izvršiti samo stručna osoba. Prilikom montaže lampe pazite da ne oštetite kabel. Značenje kablova prema bojama: crna ili smeđa (L)= faza, plava (N) = nula, i kod lampi sa 1 stepenom zaštite zeleno-žuta = uzemljenje. **RO** - Montarea și punerea în funcțiune a corpului de iluminat poate fi realizată doar de personal de specialitate! La montarea corpului de iluminat urmăriți să nu deteriorați cablurile electrice. Marcarea cu colori a cablurilor este următoarea: negru sau maro (L) = cablu de fază, albastru (N) = cablul nul, și în cazul corpului de iluminat cu clasa de împământare I.: verde-galben = împământarea. **GR** - Η τοποθέτηση και οι ρυθμίσεις πρέπει να γίνονται μόνο από ειδικό. Στην τοποθέτηση πρέπει να προσέξετε να μην προκαλέσετε φθορές στο καλώδιο. Το χρώμα των καλωδίων είναι ως εξής: μαύρο ή καφέ (L) = φάση, μπλε (N) = ουδέτερο, και σε περίπτωση φωτιστικών με προστασία ηλεκτροπληξίας κλάσης 1: κίτρινο-πράσινο = καλώδιο προστασίας; **IT** - Per la tua sicurezza, l'installazione e la messa a punto vengono eseguite solo da uno specialista!; **HR** - Za vašu sigurnost, instalacije i ugađanje izvodi samo stručna osoba!; **MK** - Za vašu bezbednost, instalacija i podcuvanje se izvedu samo od specijalista!; **PL** - Ze względów bezpieczeństwa instalację i strojenie wykonuje tylko specjalista!; **P** - Para sua segurança, a instalação e o ajuste são realizados apenas por um especialista!;



3+2  
standard  
+extended

5 YEAR TOTAL  
WARRANTY